



LITA

NUMBRA

Luminaria tipo arbotante

Ubicación	Interior IP20
Instalación	Sobrepuesta en muro
Fabricación	Latón y vidrio opalino
Lámpara	1 x led G9 3W
Carga Máxima	3W
Temperatura de color	2700K
Flujo luminoso	300lm
CRI	85
Voltaje	127Vca

Acabado LC Latón cepillado

Pantalla E Esfera
C Cilindro

Ø100

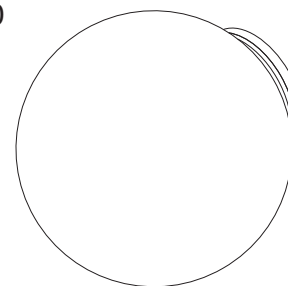

LITA01E

Ø100

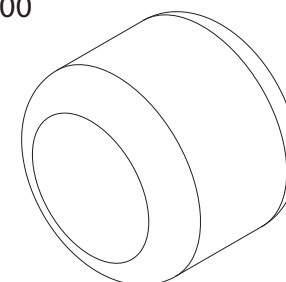

LITA01C





ONE THING
FOR MEN

ALL IN ONE
MOISTURE
ESSENCE

150 ml / 5.01 FL. OZ.

111

111

111

111

Luminaria arbotante

Ubicación	Interior IP20
Instalación	Sobrepuesta en muro
Fabricación	Acero /Aluminio/Latón y vidrio
Lámpara	1 x led G9 3W
Carga Máxima	3W
Temperatura de color	2700K
Flujo luminoso	300lm
CRI	85
Voltaje	127Vca

Acabado	AP Acero pavonado
	LC Latón cepillado
	LP Latón pavonado

Pantalla	C Cilindro
	E Esfera



Ø400

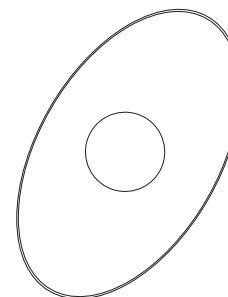

LITA02E

Ø400

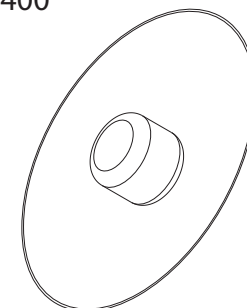

LITA02C



Luminaria tipo arbotante

Ubicación	Interior IP20
Instalación	Sobreponer
Fabricación	Latón y vidrio opalino
Lámpara	G9 3W
Carga Máxima	3W/6W/9W
Temperatura de color	2700K
Flujo luminoso	300lm /600lm/900lm
CRI	85
Voltaje	127Vca

Acabado LC Latón cepillado

Pantalla C Cilindro
E Esfera

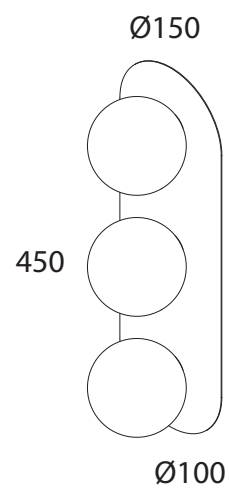

LITAD03

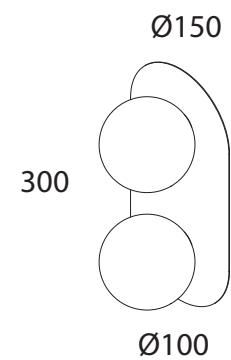

LITAD02

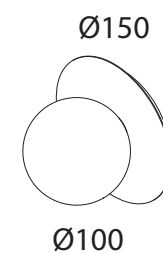

LITAD01



Luminaria suspendida

Ubicación	Interior IP20
Instalación	Suspendida
Fabricación	Latón y vidrio opalino
Lámpara	1 x led G9 3W
Carga Máxima	3W
Temperatura de color	2700K
Flujo luminoso	300lm
CRI	85
Voltaje	127Vca

Acabado LC Latón cepillado

Pantalla E Esfera
C Cilindro



Ø130

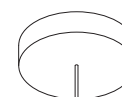

1500



Ø100

LITA03E

Ø130

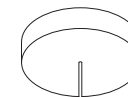

1500

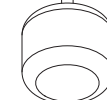

Ø100

LITA03C

Luminaria suspendida con plato

Ubicación	Interior IP20
Instalación	Suspendida
Fabricación	Latón y vidrio opalino
Lámpara	1 x led G9 3W
Carga Máxima	3W
Temperatura de color	2700K
Flujo luminoso	300lm
CRI	85
Voltaje	127Vca

Acabado LC Latón cepillado

Pantalla E Esfera
C Cilindro

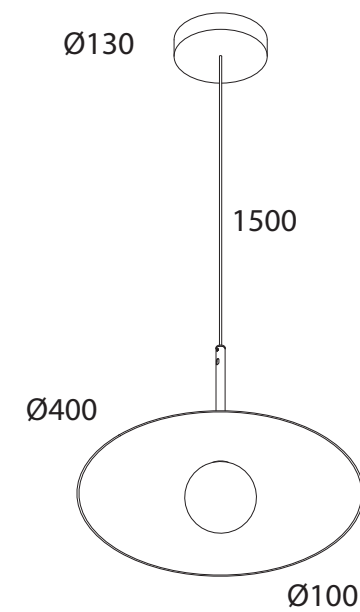

LITAD04



Luminaria suspendida

Ubicación	Interior IP20
Instalación	Suspendida
Fabricación	Latón/Acero/Aluminio
Lámpara	1 x led G9 3W
Carga Máxima	3W
Temperatura de color	2700K
Flujo luminoso	300lm
CRI	85
Voltaje	127Vca
Acabado	L Latón cepillado AP Acero pavonado PE Pintura electrostática*
Pantalla	P Plato C Cono B Bowl

*Ver diagrama de combinaciones.

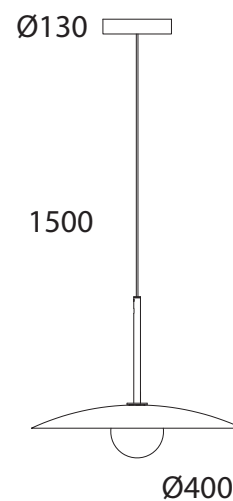

LITA03EP

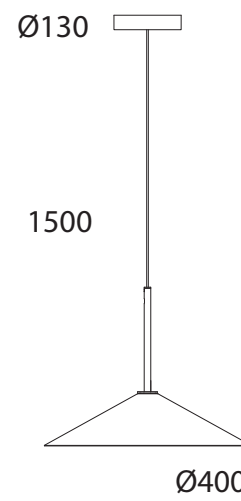

LITA03EC

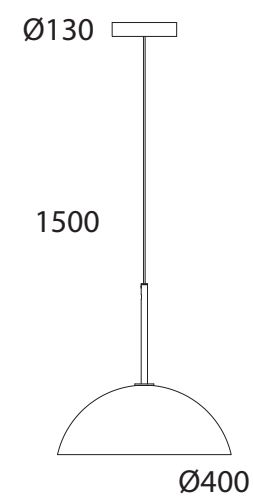

LITA03B

